

## 37U Series

### DFK 37BUX250

- IMX250 CMOS Pregius Sensor
- 5 MP
- USB3 Vision / UVC compliant
- Trigger and I/Os
- C/CS mount



The 37U series camera DFK 37BUX250 with a Sony IMX250 sensor delivers 75 frames per second with a resolution of 2448x2048 (5 MP).

32U Series: Building on the foundation of our popular One4All cameras, these next-generation USB 2.0 industrial cameras offer modern camera architecture while preserving the simplicity and affordability of the legacy One4All series.

The USB3 Vision standard allows for rapid integration into new and existing applications via The Imaging Source's [IC Imaging Control 4 SDK](#) as well as most other third-party image processing libraries.

Note: This Data Sheet is intended to provide a summary overview for an individual camera model. The Imaging Source's website also offers information on spectral sensitivity, dimensional diagrams, sensor data sheets, STEP files as well as our full product catalog. For comprehensive technical information, please refer to the Technical Reference Manual specific to each camera model.

[www.theimagingsource.com](http://www.theimagingsource.com)



## 1 Quick Facts

General	
Vision Standard	USB3 Vision (UVC compliant)
Dynamic Range	12 bit
Resolution	2448x2048
Frame Rate at Full Resolution	75

Optical Interface	
IR-Cut filter	Yes
Sensor Type	Sony IMX250LQR-C
Shutter Type	Global
Sensor Format	2/3 inch
Pixel Size	3.45 $\mu\text{m}$
Lens Mount	C/CS

Electrical Interface	
Interface	USB 3.1gen1
Supply Voltage	4.75 VDC to 5.25 VDC
Current Consumption	approx 410 mA @ 5 VDC
I/O Connector	4-pin connector for trigger and strobe or general purpose input/output

Mechanical Data	
Dimensions	H: 42 mm, W: 42 mm, L: 25 mm
Mass	76 g

Environmental Conditions	
Housing Temperature (operating)	-5 °C to 50 °C
Temperature (storage)	-20 °C to 80 °C
Humidity (operating)	20 % to 80 % (non-condensing)
Humidity (storage)	20 % to 95 % (non-condensing)



## 2 Dimensional Diagrams

### 2.1 DFK 37BUX250 C-Mount without Tripod Adapter

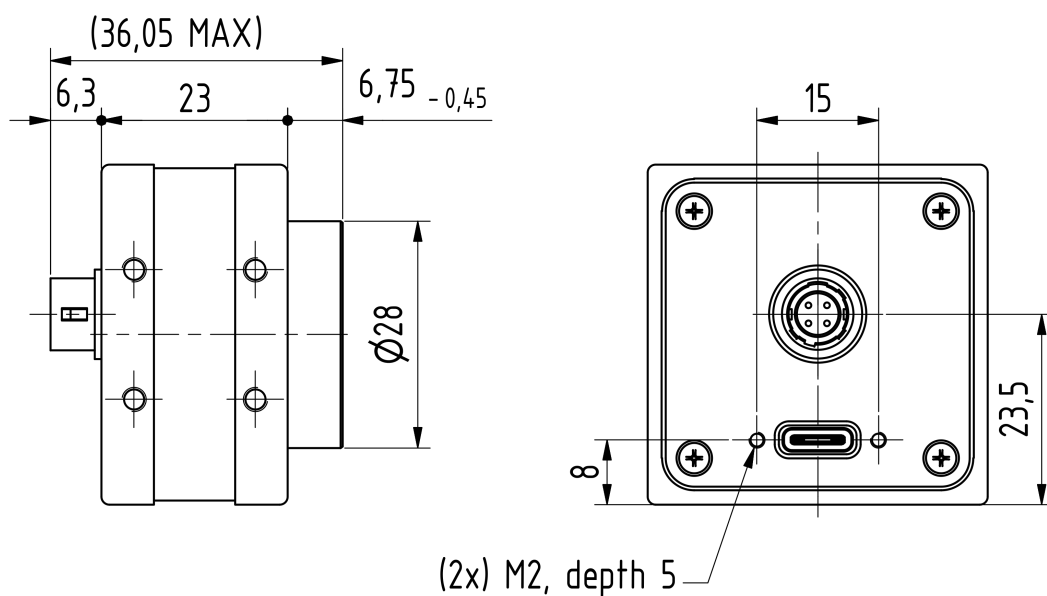
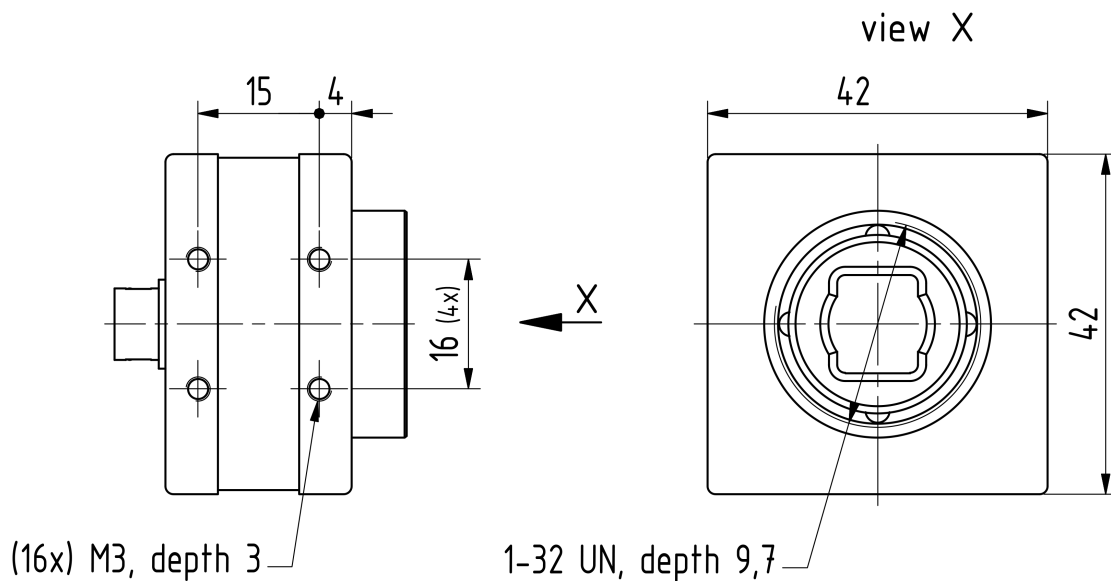

Dimensions: mm  
Tolerances: DIN ISO 2768-f





## 3 Spectral Characteristics

### 3.1 IR-Cut Filter

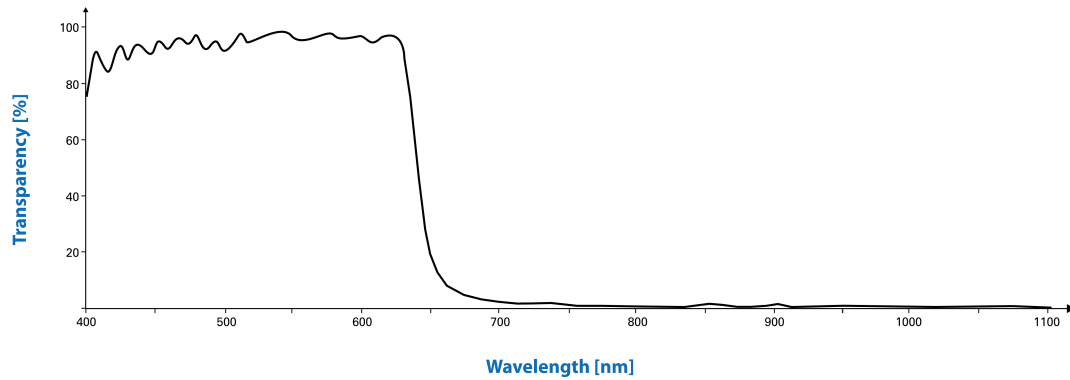

### 3.2 Spectral Sensitivity - IMX250LQR-C

Sensor: Sony IMX250/252/264/265 - courtesy of Sony Deutschland GmbH

